

Operating instructions

AdoraWash V4000

Washing machine

Thank you for choosing to buy one of our products. Your appliance is made to high standards and is easy to use. Nevertheless, please take the time to read these operating instructions in order to familiarize yourself with the appliance and get the best use out of it.

Please follow the safety precautions.

Modifications

Text, diagrams and data correspond to the technical standard of the appliance at the time these operating instructions went to press. The right to make technical modifications for the purpose of the further development of the appliances is reserved.

Validity

The model number corresponds to the first alphanumeric on the identification plate. These operating instructions apply to:

Model designation	Model number	Type
AdoraWash V4000	11023	AW4THCL, AW4THCR, AW4TLHCL, AW4TLHCR, AW4TKWHCL, AW4TKWHCR, AW4TWWHCL, AW4TWWHCR, AW4T3HCL, AW4T3HCR

Variations depending on the model are noted in the text.

Contents

1	Safety warnings	5	5.16	Opening the appliance door during washing.....	23
1.1	Symbols used.....	5	5.17	End of programme	23
1.2	General safety precautions.....	5	5.18	EcoManagement.....	25
1.3	Appliance-specific safety precautions	5	6	Favourites	25
1.4	Instructions for use.....	6	6.1	Defining favourites.....	25
2	Using for the first time	8	6.2	Changing favourites.....	26
2.1	Transport lock	8	6.3	Deleting favourites.....	26
2.2	Running the first wash cycle without any washing.....	8	6.4	Starting favourites.....	27
3	Appliance description	8	7	V-ZUG-Home	27
3.1	Construction	8	7.1	Conditions.....	27
3.2	Operating and display elements.....	9	7.2	Initial set-up.....	27
3.3	Indicator lights.....	10	8	User settings	28
3.4	Button state.....	10	8.1	Customizing user settings.....	28
4	Programme overview	10	8.2	Button tone	28
4.1	Whites and coloureds programmes	10	8.3	Background image.....	28
4.2	Textile programmes	11	8.4	Brightness	28
4.3	Standard and extra programmes	12	8.5	Language	28
4.4	Additional functions.....	12	8.6	Date and time.....	29
4.5	EcoManagement.....	14	8.7	Spin speed.....	29
5	Operating the appliance	15	8.8	Degree of soiling	29
5.1	Preparations.....	15	8.9	AquaPlus	29
5.2	Loading the washing.....	15	8.10	Automatic door opener.....	29
5.3	Adding washing detergent.....	16	8.11	Delayed start / OptiTime	30
5.4	Detergent dosage.....	17	8.12	Hygiene info.....	30
5.5	Dyeing textiles	17	8.13	Childproof lock.....	30
5.6	Selecting programme	17	8.14	Drum illumination.....	30
5.7	Selecting additional functions	18	8.15	EcoManagement.....	30
5.8	Delayed start	19	8.16	Multi-component detergent.....	30
5.9	OptiTime	20	8.17	Loosening up the washing.....	30
5.10	Separate rinsing/spinning.....	20	8.18	Soft water	31
5.11	Washing with multi-component detergent.....	21	8.19	Water options *	31
5.12	Correcting entry	21	8.20	V-ZUG-Home.....	31
5.13	Aborting a programme	21	8.21	Factory settings.....	31
5.14	With childproof lock activated.....	22	9	Demo mode	32
5.15	Drum illumination.....	22	9.1	Switching on	32

9.2	Switching off	32
10	Care and maintenance	33
10.1	Cleaning intervals	33
10.2	Cleaning the detergent dispenser drawer	33
10.3	Cleaning the water inlet filter	33
10.4	Emergency draining	34
10.5	Cleaning the foreign body trap	35
10.6	Cleaning the drum illumination	35
10.7	Opening the appliance door in the event of a power failure	36
11	Trouble-shooting	37
11.1	Error messages.....	37
11.2	Other possible problems.....	39
11.3	Unsatisfactory wash results.....	41
12	Spare parts	43
13	Technical data	44
13.1	Note for testing institutes	44
13.2	Most efficient programmes	45
13.3	Consumption values	45
13.4	Product fiche	46
13.5	VAS Vibration Absorbing System	47
13.6	Water and energy economy	47
13.7	EcoStandby.....	48
14	Washing tips	48
14.1	Energy and water economy.....	48
14.2	Avoiding damage	48
15	Disposal	49
16	Index	50
17	Service & Support	51
	Quick instructions	52

1 Safety warnings

1.1 Symbols used



Denotes important safety precautions.

Failure to observe said precautions can result in injury or in damage to the appliance or fittings!



Information and precautions that should be observed.



Information on disposal



Information about the Operating Instructions

- ▶ Indicates step-by-step instructions.
 - Describes how the appliance reacts to the steps taken.
- Indicates a list.

1.2 General safety precautions



- Read the operating instructions before using the appliance for the first time!



- This appliance can be used by children aged 8 and above and by persons with reduced physical, sensory or mental capabilities, or lack of experience and/or knowledge, provided they are supervised or have been instructed on the safe use of the appliance and have understood the hazards involved. Children shall not play with the appliance.

Cleaning and user maintenance shall not be undertaken by children without supervision.

- If an appliance is not equipped with a mains cable and a plug or other means for disconnecting from the mains with a contact opening on each pole complying with the conditions of overvoltage category III for full isolation, an isolating device must be incorporated into the permanently installed electrical installation in accordance with the installation regulations.
- If the mains cable of this appliance is damaged, it must be replaced by the manufacturer or its Customer Services or a similarly qualified person in order to avoid hazard.

1.3 Appliance-specific safety precautions

- Children under 3 years of age must be kept away from the appliance unless they are continuously supervised.
- The appliance has a maximum dry load capacity of 8 kg.

1.4 Instructions for use

Before using for the first time

- The appliance must be installed and connected to the electricity supply in accordance with the separate installation instructions. Have a qualified fitter/electrician carry out the necessary work.
- If connected to the water mains by detachable hoses, the new hose set supplied with the appliance must be used. Do not reuse old hose sets.
- Ensure ready access to the power socket being used.

Correct use

- The appliance is only suitable for washing home textiles with water and regular washing machine detergent. It is designed for use in the home and for the above-mentioned purpose only. No liability is assumed for any damage caused by improper or incorrect use.
- Any repairs, modifications or manipulations to the appliance, especially any electrically live parts, may only be carried out by the manufacturer, its customer service department or similarly qualified persons. Repairs if carried out incorrectly may cause serious injury, damage to the appliance and fittings, as well as affect the functioning of the appliance.
- If the appliance is not working properly or in case a repair is needed, follow the instructions given in the «Service and repairs» section. Please contact our Customer Services if necessary.
- Use original spare parts only.
- Before closing the appliance door and starting a programme, ensure that there are no foreign objects or pets in the drum.

Note on use

- If the appliance is not functioning properly, disconnect it from the power supply immediately.

- To protect your washing, follow the fabric care symbols and the hints and advice in the «Washing tips» section.
- Textiles that have been cleaned, treated or soaked with flammable chemicals, detergents or solvents such as benzene, alcohol, stain remover, oil, paint, wax, etc. are not to be washed in the appliance. Fire or explosion hazard! Wash materials containing such substances first by hand with water or allow the solvent to evaporate completely.
- Ensure the washing drum has stopped moving before reaching inside. Do not touch the washing drum while it is still in motion – risk of serious injury!
- Disconnect the appliance from the mains before carrying out maintenance work.

Caution: Risk to life!

- Packaging material, e.g. plastic film and polystyrene, can be dangerous for children. Danger of suffocation! Keep packaging material away from children.
- When carrying out maintenance work on the appliance, including replacing light bulbs, cut off the electricity supply to the appliance: remove the screw fuse from the holder or switch the circuit breaker off, or unplug from the mains socket.

How to avoid damaging the appliance

- Close the appliance door carefully.
- When cleaning the appliance make sure no water gets inside it. Use a moderately damp cloth. Do not spray the outside or the inside of the appliance with water. If water gets inside the appliance, it will cause damage.
- Before closing the appliance door and starting a programme, ensure that there are no foreign objects or pets in the washing drum, detergent compartment or around the foreign body trap. Foreign objects such as coins, nails, paper clips, etc. can damage parts of the appliance as well as the washing.

- During longer periods of absence, turn off the water tap before switching off the power by pulling out the mains plug. Never pull the mains plug out by the cable. Please note: The built-in overflow protection is rendered inactive when the power is switched off.
- Textiles with metal reinforcements are not to be washed in the appliance Risk of damage.
- Trainers, diving suits, rucksacks, carpets, etc. are not to be washed in the appliance.

2 Using for the first time



The appliance must be installed and connected to the electricity supply in accordance with the separate installation instructions. Have a qualified fitter/electrician carry out the necessary work.

2.1 Transport lock



Remove the transport lock (hexagon head screws at the back of the appliance) in order to avoid damage to the appliance (see installation instructions).

2.2 Running the first wash cycle without any washing

- ▶ Add a little washing detergent to compartment II of the detergent dispenser drawer (see page 16).
- ▶ Run an empty coloureds 60 °C cycle to remove any residues from the manufacturing process (see page 17).

3 Appliance description

3.1 Construction

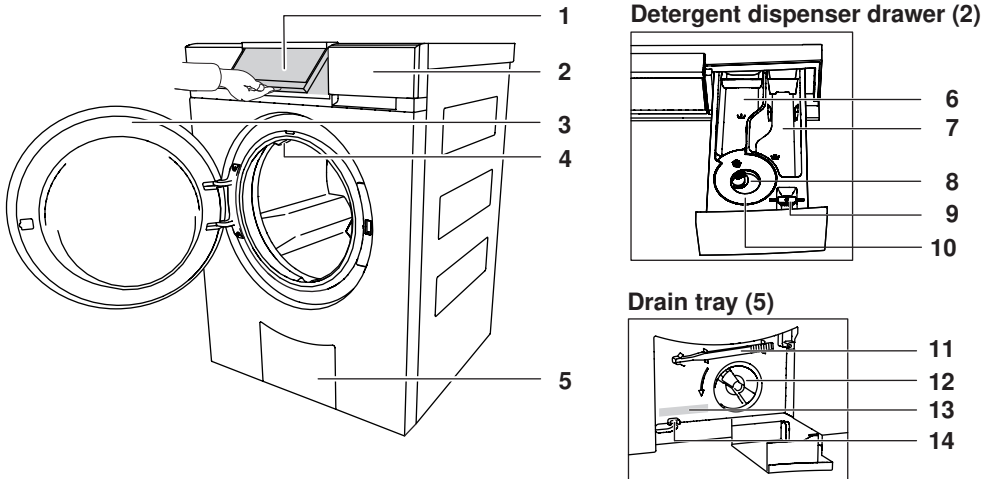

- | | | | |
|---|---|----|---|
| 1 | Operating panel (pivoting) | 9 | Flap for liquid detergent / Drain tray opener |
| 2 | Detergent dispenser drawer | 10 | Siphon for fabric conditioner |
| 3 | Appliance door | 11 | Emergency door release tool |
| 4 | Circulation nozzle | 12 | Foreign body trap |
| 5 | Drain tray | 13 | Identification plate / serial number (SN) |
| 6 | Pre-wash detergent, compartment I | 14 | Emergency door release |
| 7 | Main wash detergent, compartment II | | |
| 8 | Fabric conditioner, compartment  | | |

3.2 Operating and display elements

Operating panel

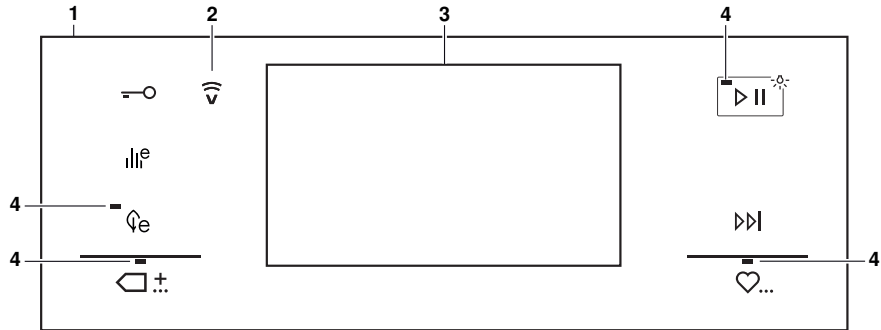

- 1 Operating panel
- 2 V-ZUG-Home display
- 3 TouchDisplay
- 4 Indicator lights

Buttons

- Door opener
- EcoManagement
- Eco
- Standard and extra programmes
- Start/Pause/Drum illumination
- End of programme / Fast forward
- Favourites

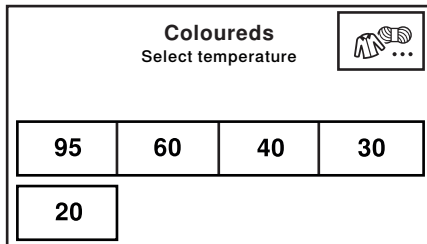

TouchDisplay



Buttons

- Textile programmes
- 95** Whites 95 °C
- 60** Coloureds 60 °C
- 40** Coloureds 40 °C
- 30** Coloureds 30 °C
- 20** Coloureds 20 °C



3.3 Indicator lights

Indicator light	Activity	State
	Indicator light is illuminated.	Function is active.
	Indicator light is flashing.	Function is selectable.
	Indicator light is not illuminated.	Function is not selectable.















3.4 Button state

Background colour	Symbol colour	State
Blue	White	Function is active.
Black	White	Function is selectable.
Black	Black	Function is not selectable.

4 Programme overview



To select the right programme, please follow the fabric care symbols on the laundry labels, e.g. . Textiles with the  fabric care label may only be washed using the «Hand wash» textile programme.

4.1 Whites and coloureds programmes

Programmes	Fabric care symbols	Load capacity
95 Whites 95 °C: For white cottons/linens e.g. bed and table linen, towels, white or colour-fast underwear.		1–8 kg
60 Coloureds 60 °C: For coloured cottons e.g. bright blouses, overalls, shirts, bed linen.	 	1–8 kg
40 Coloureds 40 °C: For coloured cottons and mixed washing e.g. coloured sweatshirts, t-shirts.	  	1–8 kg
30 Coloureds 30 °C: For coloured cottons and mixed washing e.g. t-shirts.	   	1–8 kg
20 Coloureds 20 °C: Energy-saving programme for lightly soiled textiles.	   	1–8 kg











4.2 Textile programmes

Touch the  button for the selection of textile programmes.

Programmes		Load capacity
1/3	Coloureds: Standard programme	1-8 kg
	Woollens: Gentle treatment for woollens and other delicate textiles. Only for woollens with a felt-free finish and labelled as «machine washable».	1-2.5 kg
	Hand wash: Very gentle treatment for textiles labelled with the  fabric care symbol.	1-2 kg
	Shirts: Optimized for minimizing creasing, contains steam anti-crease.	max. 7 items
2/3	Down: Optimized for the particular wetting characteristics of down fabrics. Short spin at the beginning of the programme to get rid of any air in down textiles.	max. 1 kg
	Outdoor garments: For waterproof and breathable clothing. Higher water level during washing and spinning.	1-3 kg
	Silks: For delicate silk articles. Spin speed is reduced to minimize creasing.	1-1.5 kg
	Net curtains: Reduced washing action for very gentle treatment. Higher water level during washing and spinning. The washing remains lying in the water after the final rinse (stop after rinsing).	1-2 kg
	Draining with spinning	1x 
	Draining without spinning	2x 
3/3	Baby garments: Very thorough rinsing for the protection of sensitive baby skin. If 95 °C is selected as the temperature, a pre-wash is included.	1-5 kg
	Denim: Optimized for colour loss (colour run) from denim.	1-4 kg
	FirstWash: Quick wash cycle for new textiles. Add only a very small amount of washing detergent! Not suitable for woollens and hand wash!	1-2 kg
	Black garments: Optimized rinsing through a higher water level and extended rinsing time for dark textiles.	1-4 kg





4.3 Standard and extra programmes





















Touch the  button for the selection of standard and extra programmes.

Programmes	Fabric care symbols	Load capacity
 Cotton 60 °C: The most efficient programme for washing normally soiled laundry.		1–8 kg
 Cotton 40 °C: The most efficient programme for washing normally soiled laundry.		1–8 kg
 Steam anti-crease: Dry washing is partially un-creased and made damp, ready to iron.	  	1–1.5 kg
 Proofing: For starching or proofing laundry, add the agent to the fabric conditioner compartment.		1–3 kg
 Appliance hygiene: Steam cleaning without laundry.		0 kg

4.4 Additional functions

Whenever a programme is selected, the selectable additional functions are displayed.

Additional functions	Load capacity
 Eco: Large energy savings due to reduced wash temperature. The extended washing time ensures the washing performance is maintained. Depending on programme, energy savings of about 10%-40%, extension of the washing times by 25–60 minutes and water savings of about 10%-20%.	
 Easy care: For washing requiring very gentle treatment. Increased water level, reduced washing action and lower spin speed.	3.5 kg
 Pre-wash: Suitable for heavily soiled washing. Programme duration extended about 15 minutes.	
 Delayed start: For using cheap-rate electricity (setting range of up to 24 hours). The programme starts automatically when the set time is reached.	
 OptiTime: If a programme end time has been selected, OptiTime calculates the most energy-efficient programme that can be carried out in the time remaining to programme end. OptiTime reduces the washing temperature, while the washing performance is maintained. The more time is available for washing, the more the washing temperature can be reduced. If higher wash temperatures with a germ-killing effect are needed, a corresponding programme without the OptiTime function must be selected (see page 30).	

Additional functions	Load capacity	
	Degree of soiling: Adjustment to the degree of soiling of the washing.	
	Light soiling: For lightly soiled washing.	
	Normal soiling: Extended wash time.	
	Heavy soiling: Extended wash time, higher water level, an additional rinsing cycle.	
	Soaking: The duration can be set between 0.5 and 6 hours.	
	Anti-mite: The main wash is extended and intensified. The mites are killed and the allergens are rinsed out thoroughly.	
	AquaPlus: There are 5 different settings for rinsing intensity.	
	Standard: Normal water level.	
	more water: Increased water level during the main wash and rinsing.	
	+ 1 rinse: An additional rinsing cycle.	
	more water + 1 rinse: Increased water level during the main wash and rinsing, an additional rinsing cycle.	
	Skin protection: Increased water level during rinsing, two additional rinsing cycles. Suitable for sensitive skin.	
	Spin speed: The spin speed can be changed. Delicates can be spun at a lower spin speed. However, this increases the drying time (greater energy consumption for tumble drying).	
	Sprint: Quick programme for lightly soiled washing. 2 instead of 3 rinsing cycles.	2.5 kg
20	+  : 26 mins.	Note: Add a small amount of washing detergent. A large washing load or too much washing detergent can significantly extend the programme time. Use liquid detergent only.
30	+  : 27 mins.	
40	+  : 28 mins.	
60	+  : 39 mins.	
	Steam anti-crease: Reduces creasing significantly. Loosening-up period: 60 minutes. The washing is warm and should be hung up immediately to dry or be tumble dried. The spin speed is limited to 1000 rpm.	max. 2 kg
	Separate rinsing / Separate spinning: The programme starts at the desired parts of the programme and the programme sequence is shortened (see page 20).	

Additional functions

**Load
capacity**



Bio wash: The programme sequence is adapted for the use of multi-component detergents (alkaline detergent + bleach) (see page 21).

Soap washing The programme sequence is adapted for the use of multi-component detergents (softener + soap detergent) (see page 21).



Start/Pause/Drum illumination: Touch the button to start or interrupt programmes. Touch the button again to resume the programme after being interrupted. The drum illumination can be turned on and off.

4.5 EcoManagement

Button



Only active if «EcoManagement» is turned on in the user settings (see page 30). EcoManagement provides information on the energy and water consumption of the appliance. The following statistical data can only be retrieved when no programme is running:

- Energy and water consumption of the last programme
 - Total energy and water consumption
 - Average energy and water consumption of the last 25 programmes
-

The energy and water consumption of a programme is displayed during programme selection.

At the end of a programme, the energy and water consumption of the programme that has just ended is displayed.

The values can vary according to programme, load, additional functions and user settings.

5 Operating the appliance

5.1 Preparations

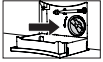

- ▶ Check the foreign body trap is inserted correctly (see page 35).



- ▶ Insert the mains plug into a mains socket.



- ▶ Turn on water tap.



- ▶ Touch the button to open the appliance door.

5.2 Loading the washing

- ▶ Load up to a maximum of 8 kg dry washing.



- full: Normally soiled whites and coloureds
- max. $\frac{3}{4}$: Heavily soiled whites and coloureds
- max. $\frac{1}{2}$: Easy care cottons, white and coloured synthetics as well as mixed fabrics
- max. $\frac{1}{4}$: Delicates, woollens, silks, polyacrylics and net curtains



For wet loads, only half-fill the washing drum. The washing drum should not be loaded with any one single, heavy item.



- ▶ Close the appliance door.
– The start screen appears.

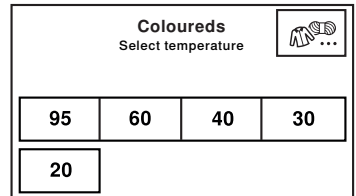

If no programme selection is made within 5 minutes, all the displays go out. Touch anywhere on the TouchDisplay at any time to display the start screen again.

5.3 Adding washing detergent

Liquid detergent

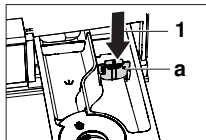

- ▶ Pull the detergent dispenser drawer out as far as it will go.
- ▶ Pull flap **a** upwards and out and insert into position **1**.



Do not fill liquid detergent past the upper mark. Liquid detergent can only be used for the main wash with programmes without a pre-wash. If washing with a delayed start, add liquid detergent to a dosing aid (e.g. ball) and then place it directly in the washing drum so that no detergent gets onto the washing during the delayed start time.

Powder detergent

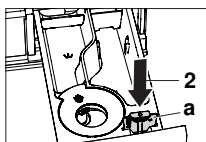

- ▶ Pull the detergent dispenser drawer out as far as it will go.
- ▶ Pull flap **a** upwards and out and insert into position **2**.

Compartments

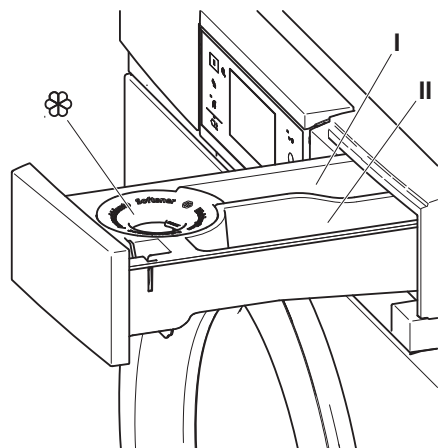

Conventional washing

Pre-wash detergent	Compartment I
Main wash detergent	Compartment II
Fabric conditioner	Compartment

Bio wash

Alkaline detergent	Compartment II
Bleach	Compartment I
Fabric conditioner	Compartment

Soap wash

Water softener	Compartment I
Soap detergent	Compartment II
Fabric conditioner	Compartment



Do not fill fabric conditioner past the upper mark.

5.4 Detergent dosage



Adding too much washing detergent can cause excess foaming. The consequences: poor wash results, damage to the appliance in the worst case.

The correct dosage depends on the degree of soiling, the wash load, the water hardness and the product used. Follow the manufacturer's dosing instructions.

Water hardness

Soft 0 °fH to 15 °fH

Medium 15 °fH to 25 °fH

Hard over 25 °fH

The local water authorities can provide information on the level of water hardness in your area.

After adding the washing detergent

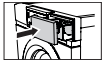

- ▶ Push the detergent dispenser drawer back in.
- ▶ Select a programme.

5.5 Dyeing textiles

Textiles can be dyed in the appliance using suitable dyeing agents. Follow the manufacturer's safety instructions and warnings.

60

- ▶ Select the desired programme (see page 17).
 - The programme starts with brief draining; water runs into the washing drum

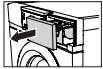

- ▶ Open detergent dispenser drawer slightly.
- ▶ Add liquid dye components.
- ▶ Close the detergent dispenser drawer.

5.6 Selecting programme

Main wash programmes

When a programme is selected, all the necessary settings for it are assigned automatically. Additional functions can be selected or deselected by using further buttons in other views.



- ▶ Close the appliance door.
 - The start screen appears.

60

- ▶ Touch the button for the desired programme.
 - The programme selected, the expected duration, the expected programme end time and the selectable additional functions are displayed. The indicator light for the selectable  button flashes.



- ▶ Touch the button.
 - The programme selected starts.

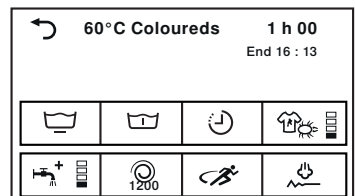
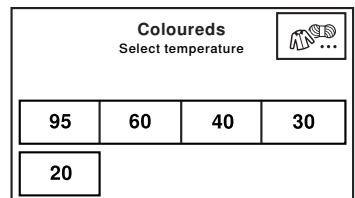

Textile programmes



- ▶ Touch the button.
 - The selection of textile programmes appears in the TouchDisplay.

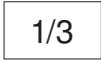

- ▶ Touch the button repeatedly until the desired textile programme is displayed.



- ▶ Touch the button for the desired textile programme.



- ▶ Touch the button for the desired temperature.
 - The programme selected and all selectable additional functions are displayed.



- ▶ Touch the button.
 - The programme selected starts.

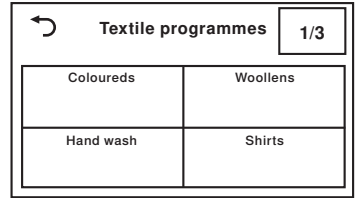

Standard and extra programmes



- ▶ Close the appliance door.



- ▶ Touch the button.
 - A selection of standard or extra programmes appears in the TouchDisplay.



- ▶ Touch the button for the desired standard or extra programme.



- ▶ Touch the button.
 - The programme selected starts.

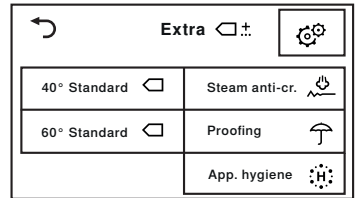

With the standard programmes, it is not possible to select the additional functions. Only delayed start is selectable.

5.7 Selecting additional functions



- ▶ Touch the button for the desired programme.
 - The programme selected and all selectable additional functions are displayed. The indicator light for the selectable button flashes.



- ▶ For desired additional functions, touch the corresponding buttons.
 - The new programme duration and programme end time are displayed.





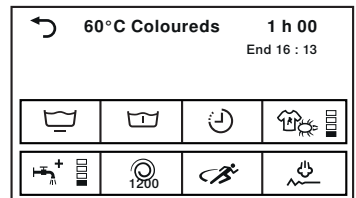



- ▶ Touch the button.
 - The programme selected starts.

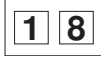

5.8 Delayed start

Selecting programme end time

The option «Programme end, OptiTime off» must be enabled in the user settings under «Delayed start / OptiTime» (see page 30).

-  ▶ Touch the button for the desired programme.
-  ▶ Touch the button.
 - The input field for the programme end time appears in the TouchDisplay.
-  ▶ Enter the time the desired programme should end.
-  ▶ Touch the button.
 - The programme end time is saved.
-  ▶ Touch the button again if any changes have to be made.
-  ▶ Touch the button.
 - ▶ The delayed start time starts. The desired programme starts so that it finishes at the programme end time.

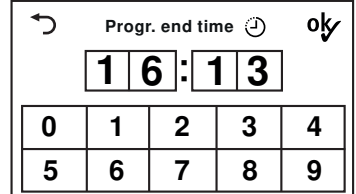

Washing can be added at any time during the delayed start time (see page 23).







Selecting programme start time

The option «Programme start» must be enabled in the user settings under «Delayed start / OptiTime». (see page 30)

- ▶ Carry out steps analogous to those described in «Selecting programme end time» (see page 19).

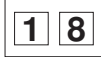

5.9 OptiTime

The option «Programme end, OptiTime on» must be enabled in the user settings under «Delayed start / OptiTime» (see page 30).

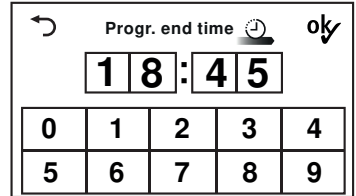
-  ▶ Touch the button for the desired programme.
-  ▶ Touch the button.
 - The input field for the programme end time appears in the TouchDisplay.
-  ▶ Enter the time the desired programme should end.
-  ▶ Touch the button.
-  ▶ Touch the button again if any changes have to be made.
-  ▶ Touch the button.
 - ▶ The delayed start time starts with the additional function «OptiTime». The desired programme starts so that it finishes at the programme end time.



5.10 Separate rinsing/spinning

-  ▶ Touch the button for the desired programme.
-  ▶ Press the button 1x.
 - Programme starts from «Rinsing».
- ▶ Press the button 2x.
 - Programme starts from «Final rinse / Conditioning».
- ▶ Press the button 3x.
 - Programme starts from «Separate spinning».

5.11 Washing with multi-component detergent

To start Bio or Soap wash, «Multi-component detergent» must be enabled in the user settings (see page 30). Ensure the alkaline detergent or soap detergent are added to the correct compartment (see page 16).

60

- ▶ Touch the button for the desired programme.



- ▶ Touch the button.
 - The selection of washing detergents appears in the TouchDisplay.

Bio wash

- ▶ Touch the desired washing detergent.



- ▶ Touch the button.
 - The programme selected starts.

Select wash detergent			
Standard		with pre-wash	
Soap wash		Bio wash	

5.12 Correcting entry

During programme selection, entries can be corrected as follows:

Clearing entries in the current view



- ▶ Touch the button.
 - Entries will be cancelled. The previous TouchDisplay appears.

Clearing all entries



- ▶ Touch the button repeatedly until the TouchDisplay goes dark.
 - All entries are cleared.

5.13 Aborting a programme



Once a programme has started, only the spin speed can be changed. For any other changes, the programme must be aborted.



- ▶ Touch the button repeatedly until «Draining» is displayed. This part of the programme cannot be skipped and will be carried out in full.

5.14 With childproof lock activated

Selecting programme

How to turn the childproof lock on/off is described in «User settings».



- ▶ Close the appliance door.
 - The input field for the code appears in the TouchDisplay.

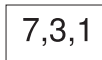

- ▶ Touch the digits 7, 3, 1 in sequence.

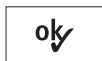

- ▶ Touch the button.
 - The appliance is unlocked.



- ▶ Touch the button for the desired programme.
 - Further steps can be taken without further regard to the childproof lock. If no programme selection is made within the next 20 seconds, the input field for the code appears in the TouchDisplay again.

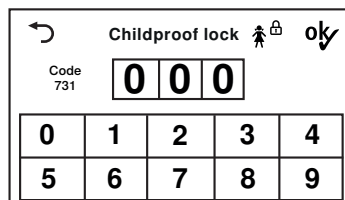

After being unlocked, the appliance can be operated normally. The childproof lock is automatically activated as soon as the programme starts.

Aborting programme / opening appliance door at end of programme



- ▶ Touch the button.
 - The input field for the code appears in the TouchDisplay.

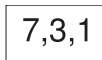

- ▶ Touch the digits 7, 3, 1 in sequence.

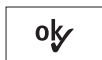

- ▶ Touch the button.
 - The appliance is unlocked.



- ▶ Touch the button repeatedly until «Draining» appears in the TouchDisplay.
 - The appliance door opens.

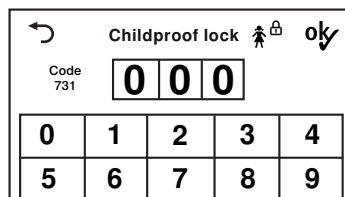

5.15 Drum illumination

The drum illumination automatically switches on whenever the appliance door is opened and switches off when it is closed. If the appliance door is left open, the drum illumination switches off automatically within 2 minutes.



- ▶ Touch the button to switch the drum illumination on or off when the appliance door is open.



If the appliance door is opened during or at the end of the standard programme, the drum illumination does not switch on automatically because this is the most energy-efficient programme and the energy requirements are reduced to a minimum (see page 45).

5.16 Opening the appliance door during washing

The appliance door can be opened when the indicator light for the  button is illuminated.

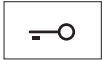

- ▶ Touch the button.
 - The appliance door opens. Laundry can be added or removed.



- ▶ Close the appliance door.



- ▶ Touch the button.
 - The programme is resumed.



In the event of a power failure, the appliance door can only be opened using the emergency door release (see page 36). The programme sequence is automatically resumed following such a power failure.

5.17 End of programme

Unloading the washing before time

Shortly before the end of the programme, the washing is loosened up. This takes about 1–2 minutes.



If steam anti-crease has been selected, the loosening-up period is extended to about 60 minutes to further prevent creasing.

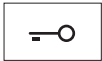

- ▶ Touch the button to unload the washing during the loosening-up phase.

Door opener

The user settings that are enabled determine whether the appliance door opens automatically when the programme ends (see page 29) and whether information on energy and water consumption is displayed or not (see page 30).

- «Automatic door opener On»:

Once a programme has finished,

- the appliance door opens automatically.
- the washing can be unloaded.

- «Automatic door opener Off»:

Once a programme has finished,

- «End of programme» is displayed in the TouchDisplay for about 20 minutes.
- information on the energy and water consumption (see page 25) is displayed in the TouchDisplay, provided «EcoManagement» has been turned on (see page 30).

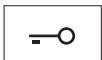

- ▶ Touch the button to open the appliance door and unload the washing at any time.

Stop after rinsing

The washing remains lying in the water after the final rinse. The water must be drained off before the washing can be unloaded.



- ▶ Touch the button 1x.
 - The washing is spun at the spin speed set for the programme.
 - The water is pumped off.

Or:



- ▶ Touch the button 2x.
 - The washing is not spun.
 - The water is pumped off.

Hygiene recommendation

Washing almost exclusively with low temperatures will result in the formation of foul smelling coatings in the appliance.

To prevent this, a «Hygiene recommendation» indicates when a wash of at least 60° C or carrying out the «Appliance hygiene» programme is recommended for hygiene reasons.



- ▶ Touch the button.
- ▶ Run the next wash cycle at least at 60 °C.

Or:

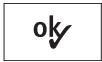

- ▶ Touch the button.
- ▶ Under standard and extra programmes, select the «Appliance hygiene» programme (see page 12).

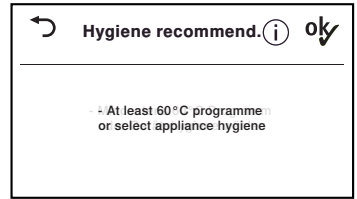

Each time after use

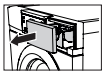

- ▶ Clean the detergent dispenser drawer.
- ▶ To allow the washing drum and door seal to dry between wash days, open the appliance door and pull the detergent dispenser drawer out as far as it will go.



- ▶ Carefully remove any deposits or foreign objects from out of the door seal.



Incorrect handling can result in damage to the appliance!

The drum illumination is located in the door seal. Care must be taken when cleaning the door seal to avoid damaging the drum illumination.

5.18 EcoManagement

Only active if «EcoManagement» is turned on in the user settings (see page 30).

Displaying estimate during programme selection

The expected energy and water consumption can be displayed during additional function selection.

-  ▶ Touch the desired programme.
- The programme selected with the expected energy and water consumption appears in the TouchDisplay.



Displaying last programme

The energy and water consumption of the last programme can be displayed if no programme is running.

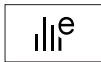
-  ▶ Touch the button.
- The energy and water consumption of the last programme run is displayed.

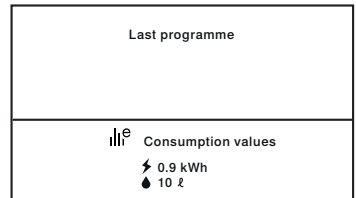

Displaying total and average consumption

Total and average consumption can be displayed if no programme is running.

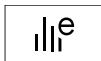
-  ▶ Hold the button depressed for 3 seconds.
- Total and average consumption are displayed.

-  ▶ Touch the button to end statistic retrieval.

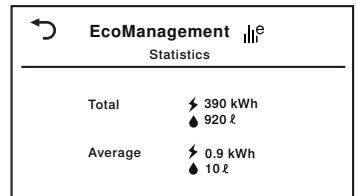

6 Favourites

Simple start to frequently used programmes.

6.1 Defining favourites

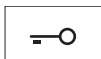
-  ▶ Touch the button.
- The appliance door opens.

-  ▶ Touch the button.

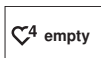
-  ▶ Touch one of the favourite buttons.

-  ▶ Select programme and additional functions.



▶ Touch the button.

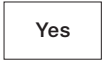

▶ Touch the button to save the favourite programme.

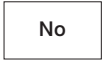

▶ Touch the button to cancel the action.

6.2 Changing favourites



▶ Touch the button.
– The appliance door opens.



▶ Touch the button.

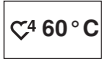

▶ Touch the favourite programme to be changed.



▶ Touch the button.
▶ Make the changes.



▶ Touch the button.

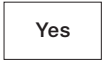

▶ Touch the button to save the favourite programme.

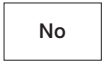

▶ Touch the button to cancel the action.

6.3 Deleting favourites

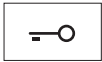

▶ Touch the button.
– The appliance door opens.



▶ Touch the button.



▶ Touch the favourite programme to be deleted.



▶ Touch the button.
– The favourite programme is cleared.

6.4 Starting favourites



- ▶ Close the appliance door.



- ▶ Touch the button.



- ▶ Touch the desired favourite programme.



- ▶ Touch the button.
 - The programme selected starts.

7 V-ZUG-Home

7.1 Conditions

The following conditions must be met for full use of V-ZUG-Home:

- Access to the internet and to Google Play™ Store / App Store®
- a wireless network that meets one of the following standards: 2.4GHz 802.11 b/g/n
- Smartphone or tablet that is connected to the wireless network
- System requirements for smartphone or tablet: from Android 6.0 or from iOS 11.0



Google Play™ is a trademark of Google Inc.



Apple and the Apple logo are trademarks of Apple Inc., registered in the U.S. and other countries. App Store® is a service mark of Apple Inc.

7.2 Initial set-up

- ▶ Set to the «Display» or «Operate and display» mode under «V-ZUG-Home» in the user settings.
- ▶ Enable Bluetooth on the smartphone or tablet.
- ▶ Search the Google Play™ Store or the App Store® for «V-ZUG».
- ▶ Install and open the V-ZUG App.
- ▶ In the V-ZUG App, add the appliance.
- ▶ Press +.
 - A 6-digit PIN appears in the display of the appliance.
- ▶ Enter the 6-digit PIN in the app.
 - All available wireless networks appear in the app.
- ▶ Select a wireless network.
- ▶ Enter the password for the wireless network.
 - The appliance is connected to the wireless network.



Further information can be found in the V-ZUG-Home operating instructions or on home.vzug.com.

8 User settings



Providing no programme is running and no error messages are displayed, the user settings can be changed.

8.1 Customizing user settings



▶ Close the appliance door.



▶ Touch the button.
– The «Extra» menu appears in the TouchDisplay.



▶ Touch the button.
▶ Select and change desired settings and submenus.

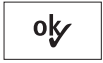

▶ Touch the button to save the selected setting.



▶ Touch the button to select and change any other settings.



▶ Touch the button to exit user settings.

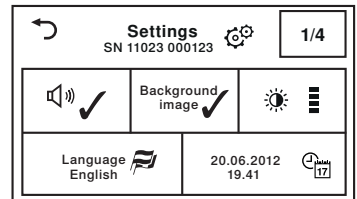
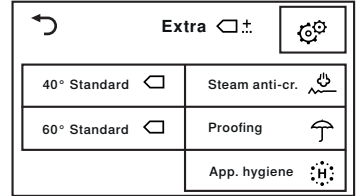

8.2 Button tone

The button tone can be turned on and off. The button tone for the and buttons cannot be turned off.

- On (factory setting)
- Off

8.3 Background image

The background image of the TouchDisplay can be turned off. In this case, the background appears black.

- On (factory setting)
- Off

8.4 Brightness

The display can be adjusted to the prevailing light conditions.

- Dark
- Medium bright
- Bright (factory setting)
- Very bright

8.5 Language

The language is set during the initial set-up of the appliance. It can be changed.

- German
- ...

8.6 Date and time

Time and date must be reset after the power supply has been interrupted for about 5 weeks. The appliance must not be disconnected from the mains supply for at least 30 minutes after making the settings.

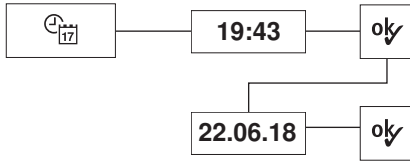

- Automatic summer/winter time On (factory setting)
- Automatic summer/winter time Off

8.7 Spin speed

An increase in the spin speed is only possible for suitable programmes. A reduction in the spin speed is possible for all programmes.

- 400
- 600
- 800
- 100
- 1200 (factory setting)
- 1400
- 1600

8.8 Degree of soiling

There are 3 settings for degree of soiling.

- Light (factory setting)
- Normal
- Heavy

8.9 AquaPlus

There are 5 settings for rinsing intensity.

- Standard (factory setting)
- More water
- + 1 rinse
- More water + 1 rinse
- Skin protection

8.10 Automatic door opener

When the function is turned on, the appliance door opens automatically when the programme ends. When the function is turned off, the appliance door can be opened by touching the  button.

- On (factory setting)
- Off

8.11 Delayed start / OptiTime

When the «Programme start» function is turned on, the time a programme should start running can be defined.

When the «Programme end» function is turned on, the time a programme should end can be defined. If the «OptiTime» function is also turned on, the «OptiTime» function is automatically added whenever a delayed start is selected.

- Programme start
- Programme end, OptiTime on
- Programme end, OptiTime off (factory setting)

8.12 Hygiene info

When the function is turned on, a wash of at least 60 °C is recommended whenever for hygiene reasons the formation of foul smelling coatings in the appliance is to be prevented.

- On (factory setting)
- Off

8.13 Childproof lock

The childproof lock prevents a programme from being started accidentally. The appliance can only be operated after first entering the code 731.

- On
- Off (factory setting)

8.14 Drum illumination

When this function is activated, the drum illumination automatically switches on whenever the appliance door is opened and switches off whenever it is closed.

- On (factory setting)
- Off

8.15 EcoManagement

When this function is activated, the estimated consumption values appear at the start of the programme and the actual consumption values appear at the end of the programme. The saved consumption values can be deleted under «Statistics».

- On (factory setting)
- Off
- Statistics
- Information

8.16 Multi-component detergent

When the function is turned on, the desired type of washing detergent can be selected under the additional function «Pre-wash».

- On
- Off (factory setting)

8.17 Loosening up the washing

Touch the  button at any time to open the appliance door. The washing can be unloaded.

- 30 seconds (factory setting)
- 10 minutes
- 30 minutes
- 6 hours

8.18 Soft water

When the function is turned on, adjusting for very soft water prevents heavy foaming.

- On
- Off (factory setting)

8.19 Water options *

* Depending on model

The appliance is equipped 2 water connection options: Either 2 water connections for hot and cold water or 2 water connections for hard and soft water.

Water connections for hot and cold water: Either a high or a low mixing temperature can be set for the main wash. Either a hot or a cold rinse temperature can be set for rinsing. All detailed settings are described in the installation instructions on «Water options».

- Mixing temperature high
- Mixing temperature low
- Rinse temperature cold
- Rinse temperature hot

Water connections for hard and soft water: Soft water is used for the main wash and the first rinse. Water for subsequent rinse cycles is drawn from the hard water connection.

- Yes
- No

8.20 V-ZUG-Home

With V-ZUG-Home (see page 27), you can access your appliances over the V-ZUG App to, for instance

- switch off a running appliance
- call up the status of your household appliances.



- Operate and display
- Display
- Off (factory setting)



Further information can be found in the V-ZUG-Home operating instructions or on home.vzug.com.

8.21 Factory settings

The factory settings can be restored. The language if changed is not reset to the factory setting.

- : Restore
- : Do not restore



Any favourites that have been saved will also be deleted.

9 Demo mode

The appliance can be fully operated in the demo mode, but it will not wash.



The demo mode can only be switched on or off when the appliance door is open.

9.1 Switching on

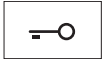

- ▶ Touch the button.
 - The appliance door opens.



- ▶ Simultaneously depress the buttons for 5 seconds until the «Demo mode» menu appears in the TouchDisplay.



- ▶ Touch the button.
 - The demo mode is selected.



- ▶ Touch the button.
 - The setting is saved.
 - The TouchDisplay goes dark.

9.2 Switching off

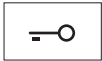

- ▶ Touch the button.
 - The appliance door opens.

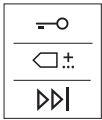

- ▶ Hold the buttons depressed at the same time.
 - The «Demo mode» menu appears in the TouchDisplay.



- ▶ Touch the button.
 - The demo mode is not selected.



- ▶ Touch the button.
 - The setting is saved.
 - The TouchDisplay goes dark.

10 Care and maintenance

Using the correct dosage of detergent will automatically clean the inside of the appliance. Immediately wipe away all traces of detergent with a soft cloth to avoid staining.

10.1 Cleaning intervals

Appliance part	Cleaning interval
Detergent dispenser drawer	▪ After each wash
Water inlet filter	▪ When prompted «A9 Check water inlet»
Foreign body trap	▪ 1× per month
Drum illumination	▪ As required

10.2 Cleaning the detergent dispenser drawer

Cleaning the detergent compartments

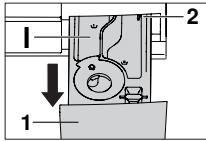

- ▶ Pull the detergent dispenser drawer **1** out as far as it will go.
- ▶ Push the blue release lever **2** to the left and pull the detergent dispenser drawer **1** completely out.
- ▶ Wash out the detergent compartments.
- ▶ Clean the duct under the pre-wash detergent compartment **I**.
- ▶ Insert the detergent dispenser drawer **1** again correctly.

Cleaning the siphon and suction tube

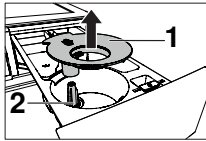

- ▶ Pull siphon **1** in fabric conditioner compartment upwards and out.
- ▶ Clean the siphon **1** and suction tube **2**.
- ▶ Insert the siphon **1** again correctly.

10.3 Cleaning the water inlet filter

 **Test the water inlet for leaks following maintenance work.**

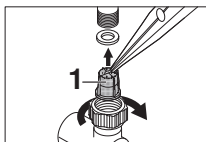

- ▶ To avoid blockages, periodically check and, if necessary, clean the water inlet filter **1**.

10.4 Emergency draining

 **The water in the appliance may be hot. Scalding hazard! Allow to cool down before emergency draining.**

In the event of a blocked water outlet or drain pump, a malfunction or a power failure, if there is water still in the appliance it must be drained off as follows:

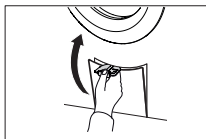

▶ Open the drain tray with the flap for liquid detergent.

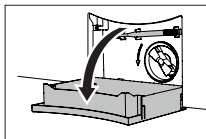

▶ Fold the drain tray right down. It also functions as a receptacle for collecting any water that runs out.

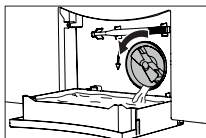

▶ Carefully release the foreign body trap somewhat by turning it anti-clockwise and steadily drain off the water.

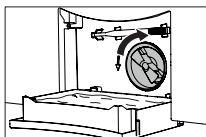

▶ Close the foreign body trap by turning it clockwise and remove the drain tray from the front.

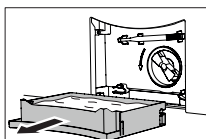

▶ Empty the drain tray and then put it back, pushing it in straight as far as it will go.

 The drain tray can be removed and a larger receptacle used in its place to drain off the water. The appliance can hold up to 30 litres of water.

10.5 Cleaning the foreign body trap



Clean the foreign body trap at regular intervals as well as after washing, for instance, pet blankets or other wash items that cause a thick build-up of fluff.

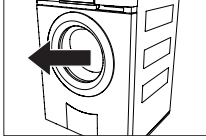

- ▶ Open the appliance door.

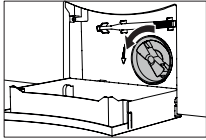

- ▶ Drain off any residual water (see page 34).

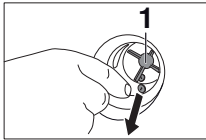

- ▶ Remove any foreign objects (buttons, coins, etc.) from around the impeller **1**.

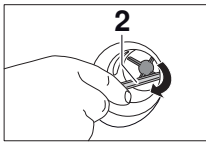

- ▶ Using the emergency door release tool **2**, check that the drain pump impeller can turn.



The impeller **1** may turn stiffly. This is construction related and does not indicate the presence of any foreign object or defect. If the impeller does not turn, please contact our Customer Services.

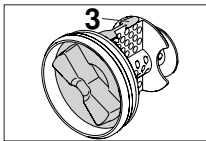

- ▶ Insert the foreign body trap – with the arrow-like cam **3** pointing upwards – as far as it will go.
- ▶ Screw the foreign body trap in clockwise as far as it will go.

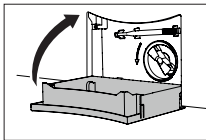

- ▶ Put the drain tray back and close it to.

10.6 Cleaning the drum illumination

- ▶ If necessary, wipe carefully with a soft cloth.

10.7 Opening the appliance door in the event of a power failure

 Wait until the washing drum is completely stationary. A washing drum that is still rotating poses a risk of serious injury.

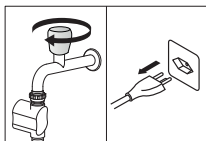

▶ Close the water tap and disconnect the appliance from the mains.

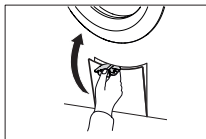

▶ Open the drain tray with the flap for liquid detergent.

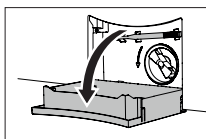

▶ Fold the drain tray right down. If necessary, carry out emergency draining.

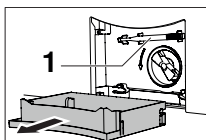

▶ Remove drain tray.
▶ Remove the emergency door release tool 1 from its bracket.

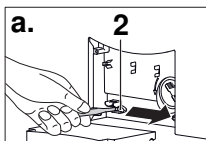

▶ Insert emergency door release tool into blue opening cap 2 and turn in direction of arrow.

a. Door opens from right

b. Door opens from left

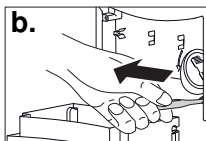

The appliance door springs open.









If the emergency door release tool is missing, a screw driver can be used instead.

11 Trouble-shooting

You may be able to trouble-shoot the following malfunctions yourself. If not, note down the error message in full (message, F and E numbers) and call Customer Services.

11.1 Error messages

Display	Possible cause	Solution
A2 Check water outlet	<ul style="list-style-type: none"> ▪ The foreign body trap is clogged. ▪ The drain pump is blocked. ▪ The drain hose is bent or kinked. ▪ The outlet or drain trap is clogged. 	<ul style="list-style-type: none"> ▶ Check cause (see page 35). ▶ Touch the  button. ▶ Restart the programme.
A3 Clean foreign body trap	<ul style="list-style-type: none"> ▪ The foreign body trap is clogged. ▪ The circulation nozzle is clogged. 	<ul style="list-style-type: none"> ▶ Check cause (see page 35). ▶ Touch the  button. ▶ Restart the programme.
A5 Spin stop: Unbalanced load	<ul style="list-style-type: none"> ▪ Large items are unevenly distributed in the washing drum. ▪ Pillows or similar items in the wash. ▪ Wash items are tangled. 	<ul style="list-style-type: none"> ▶ Wash large and small items together. ▶ Remove the pillows. ▶ Spin the washing again. ▶ Spin the pillows separately. ▶ Separate the wash items. ▶ Fasten duvet covers and pillow cases. ▶ Spin the washing again.
A6 Check foreign body trap	<ul style="list-style-type: none"> ▪ The foreign body trap is missing or is not sitting correctly. 	<ul style="list-style-type: none"> ▶ Check cause (see page 35). ▶ Touch the  button. ▶ Restart the programme.
A9 Check water inlet	<ul style="list-style-type: none"> ▪ The water tap is turned off. ▪ The water inlet filter is clogged. ▪ Water supply is interrupted. ▪ Water pressure is too low. 	<ul style="list-style-type: none"> ▶ Clean water inlet filter or restore water supply (see page 33). ▶ Touch the  button. ▶ Restart the programme.
F6/E77 see instructions SN XXXXX XXXXXX	<ul style="list-style-type: none"> ▪ Anti-leak protection was triggered. 	<ul style="list-style-type: none"> ▶ Turn off water tap. ▶ Note down error message in full and appliance's SN. ▶ Touch the  button. ▶ Call Customer Services.



Display	Possible cause	Solution
FXX/EXX see instructions SN XXXXX XXXXXX	<ul style="list-style-type: none"> ▪ Various situations can lead to an "F" message. 	<ul style="list-style-type: none"> ▶ Touch the  button. ▶ Switch the power supply off for about 1 minute. ▶ Switch the power supply back on again and select a new programme.
	<ul style="list-style-type: none"> ▪ If the error appears again: 	<ul style="list-style-type: none"> ▶ Note down error message in full and appliance's SN. ▶ Interrupt the water and power supply. ▶ If there is laundry in the appliance: carry out emergency draining, use emergency door release and unload laundry. ▶ Call Customer Services.
H20	<ul style="list-style-type: none"> ▪ The water inlet counter is defective. It is still possible to wash without a problem. The water consumption displayed can deviate from the actual consumption. 	<ul style="list-style-type: none"> ▶ Call Customer Services.
U1/E27 see instructions SN XXXXX XXXXXX	<ul style="list-style-type: none"> ▪ Faulty electrical connection. ▪ Overvoltage. 	<ul style="list-style-type: none"> ▶ Touch the  button. ▶ Switch the power supply off for about 1 minute. ▶ Switch the power supply back on again and select a new programme.
	<ul style="list-style-type: none"> ▪ If the error appears again: 	<ul style="list-style-type: none"> ▶ Have an electrician check the house installation. ▶ Note down error message in full and appliance's SN. ▶ Disconnect from the power supply. ▶ Call Customer Services.
Foam in main wash: Rinsing extended	<ul style="list-style-type: none"> ▪ If there is very heavy foaming, the programme is automatically extended by a rinsing cycle. This improves the wash results, but extends the programme time. 	<ul style="list-style-type: none"> ▶ Reduce the amount of washing detergent used next time. ▶ Adjust detergent dosage to the water hardness (see page 17).

Display	Possible cause	Solution
Hygiene recommendation	<ul style="list-style-type: none"> ▪ No wash cycle has been carried out at a temperature of at least 60 °C for a longer period of time. 	<ul style="list-style-type: none"> ▶ With one of the next wash cycles carry out a wash with at least 60° C. <p>Or:</p> <ul style="list-style-type: none"> ▶ Run «Appliance hygiene» programme without laundry (see page 24).
Inlet water very cold: Heating extended	<ul style="list-style-type: none"> ▪ Inlet water is very cold. Heating is extended. 	<ul style="list-style-type: none"> ▶ No action is necessary.
Too many items: Heating extended	<ul style="list-style-type: none"> ▪ The selected programme is intended for a smaller load. Heating and possibly rinsing is extended. 	<ul style="list-style-type: none"> ▶ Adjust load to the max. load size (see page 15).
Large unbalanced load: Spin extended	<ul style="list-style-type: none"> ▪ The appliance optimizes the distribution of the wash load to compensate an unbalanced load. The final spin is extended. 	<ul style="list-style-type: none"> ▶ Wash large and small items together to avoid large unbalanced loads.

11.2 Other possible problems

Problem	Possible cause	Solution
The washing has not been spun or has been spun insufficiently.	<ul style="list-style-type: none"> ▪ The spin speed is set too low. 	<ul style="list-style-type: none"> ▶ Increase the spin speed for the next wash cycle (see page 29).
	<ul style="list-style-type: none"> ▪ Too unbalanced a load in the washing drum. 	<ul style="list-style-type: none"> ▶ Wash large and small items together.
	<ul style="list-style-type: none"> ▪ «Steam anti-crease» was selected and the appliance was not standing level. 	<ul style="list-style-type: none"> ▶ Optimize appliance set-up according to installation instructions.
The appliance vibrates heavily when spinning.	<ul style="list-style-type: none"> ▪ The transport lock has not been removed. 	<ul style="list-style-type: none"> ▶ Remove transport lock.
	<ul style="list-style-type: none"> ▪ The feet of the appliance are not properly adjusted. 	<ul style="list-style-type: none"> ▶ Set appliance feet so that the appliance stands level.
	<ul style="list-style-type: none"> ▪ The load could not be optimally balanced in the washing drum. 	<ul style="list-style-type: none"> ▶ Wash large and small items together.

11 Trouble-shooting

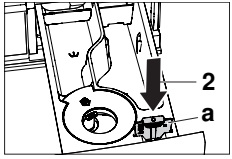

Problem	Possible cause	Solution
At the end of the programme, the appliance door cannot be opened with the  button.	<ul style="list-style-type: none"> ▪ The appliance door is stuck. ▪ An interruption in the power supply. 	<ul style="list-style-type: none"> ▶ Press hard against the lock area of the appliance door (i.e. front edge of appliance door). ▶ Touch the  button again. ▶ Use the emergency door release (see page 36).
Water sounds after programme has finished when washing drum is turned by hand.	<ul style="list-style-type: none"> ▪ The vanes are filled with water to compensate the unbalanced load. 	<ul style="list-style-type: none"> ▶ The water is automatically pumped off. No action is necessary.
Traces of conditioner or water in fabric conditioner compartment.	<ul style="list-style-type: none"> ▪ Siphon in fabric conditioner compartment is missing or not inserted correctly. ▪ Siphon or suction tube is clogged. 	<ul style="list-style-type: none"> ▶ Insert the siphon correctly (see page 33). ▶ Clean siphon and suction tube (see page 33).
Traces of powder detergent in detergent compartment.	<ul style="list-style-type: none"> ▪ Damp or lumpy washing detergent. ▪ Detergent compartment was damp and a delayed start was selected. ▪ Water flow pressure is too low. ▪ Water inlet is scaled up. ▪ Flap a was inserted in position 1 for liquid detergent. 	<ul style="list-style-type: none"> ▶ Store washing detergent in a dry place. ▶ Wipe detergent compartment dry before adding the detergent. ▶ Open water tap fully. ▶ Check water supply and, if necessary, clean the water inlet filter (see page 33). ▶ Pull flap a out and insert into position 2 (see page 16).
		
Laundry is still dry after programme has finished – no error message.	<ul style="list-style-type: none"> ▪ The demo mode is switched on. 	<ul style="list-style-type: none"> ▶ Switch the demo mode off (see page 32).

Problem	Possible cause	Solution
The consumption values for Eco-Management displayed are too high.	<ul style="list-style-type: none"> ▪ The values can vary according to programme, load, additional functions and user settings. ▪ System-related fluctuations cannot be ruled out. 	<ul style="list-style-type: none"> ▶ Observe the user settings and additional functions.
The programme takes significantly longer than indicated.	The programme times given serve only as a guide. The duration can be extended by, for example, the following factors:	<ul style="list-style-type: none"> ▶ Further information can be found in the section on «Consumption values» (see page 45).
	<ul style="list-style-type: none"> ▪ Inlet water is very cold. Heating is extended. 	<ul style="list-style-type: none"> ▶ No action is necessary.
	<ul style="list-style-type: none"> ▪ Washing detergent dosage is too high. 	<ul style="list-style-type: none"> ▶ Reduce the amount of washing detergent used next time. ▶ Adjust detergent dosage to the water hardness (see page 17).
	<ul style="list-style-type: none"> ▪ Too unbalanced a load during the intermediate spin. 	<ul style="list-style-type: none"> ▶ Follow the trouble-shooting solution for error message A5 (see page 37).
	<ul style="list-style-type: none"> ▪ Flow of inlet water is low. 	<ul style="list-style-type: none"> ▶ No action is necessary.
	<ul style="list-style-type: none"> ▪ There are deposits or fluff build-ups in the draining system or foreign body trap. 	<ul style="list-style-type: none"> ▶ Follow the trouble-shooting solution for error message A2 (see page 37).

11.3 Unsatisfactory wash results

Result	Possible cause	Solution
White residue on washing	<ul style="list-style-type: none"> ▪ Despite intensive rinsing, badly soluble compounds in the detergent can be left on the washing. 	<ul style="list-style-type: none"> ▶ Shake out or brush the wash items. ▶ Wash the items again with just a little washing detergent. ▶ Use a liquid detergent that does not contain zeolites. ▶ Select the «Black garments» textile programme.
Grey residue on washing	<ul style="list-style-type: none"> ▪ Grease and dirt particles left behind. ▪ Residue from detergent, limescale and dirt 	<ul style="list-style-type: none"> ▶ Increase detergent dosage. ▶ Use heavy-duty washing detergent. ▶ Adjust amount of detergent to water hardness and degree of soiling of washing (see page 17).
	<ul style="list-style-type: none"> ▪ Washing drum is overloaded. 	<ul style="list-style-type: none"> ▶ Put less laundry into the washing drum (see page 15).

11 Trouble-shooting

Result	Possible cause	Solution
Washing feels hard	<ul style="list-style-type: none"> Poor rinsing effect through very soft water (below 15 °fH). 	<ul style="list-style-type: none"> Select user setting «Soft water» (see page 31).
Unsatisfactory wash result using detergent for coloureds	<ul style="list-style-type: none"> Washing detergent used does not contain bleach. Exceptionally heavily soiled washing. 	<ul style="list-style-type: none"> Use washing detergent containing bleach (see page 16). More intensive programme, e.g. degree of soiling   «heavily soiled».
Unsatisfactory wash result using liquid detergent	<ul style="list-style-type: none"> Liquid detergent does not contain bleach. 	<ul style="list-style-type: none"> Use washing detergent containing bleach (see page 16).
Soap deposits on washing	<ul style="list-style-type: none"> Water hardness is too high. 	<ul style="list-style-type: none"> Soap detergent should only be used if the water hardness is below 25 °fH (see page 17).
Unsatisfactory rinsing performance	<ul style="list-style-type: none"> Too much washing detergent. Very soft water (below 15 °fH) 	<ul style="list-style-type: none"> Adjust washing detergent dosage to water hardness and degree of soiling (see page 17). Select user setting «Soft water» (see page 31).
Fabric stains	<ul style="list-style-type: none"> Rust stains Chemical effect Residues from hair care products, cosmetics and plants can react with the suds to cause a chemical reaction that can result in staining. 	<ul style="list-style-type: none"> Brush out pockets in garments. Wash items with metal parts separately.
Colour run	<ul style="list-style-type: none"> Non-fast colours in the wash. Items in the wash whose colour has run. 	<ul style="list-style-type: none"> Wash white and coloured textiles separately. Follow fabric care labels. Empty garment pockets.

Result	Possible cause	Solution
Holes, rips or tears	▪ Items in the wash with zips or hooks open.	<ul style="list-style-type: none"> ▶ Fasten zip fasteners and hooks before washing. ▶ Wash delicates in a laundry bag or pillow case. ▶ Turn pockets inside out. ▶ Empty garment pockets.
	▪ Chemical effect of washing detergent, textile quality	<ul style="list-style-type: none"> ▶ Do not put washing detergent directly onto the laundry.
	▪ Washing drum damaged by foreign objects (e.g. nails, paper clips, etc.)	<ul style="list-style-type: none"> ▶ Inspect washing drum for foreign objects and damage. ▶ Remove foreign objects. ▶ Call Customer Services if the washing drum is damaged.
Fabric wear	▪ Washing drum overloaded	<ul style="list-style-type: none"> ▶ Put less laundry into the washing drum (see page 15).
	▪ Friction between fabrics during washing.	<ul style="list-style-type: none"> ▶ Select additional function «Easy care».
	▪ Pilling	<ul style="list-style-type: none"> ▶ Turn items inside out before washing.

12 Spare parts

Please give model designation, model number and type when ordering parts (see page 2).



Drain hose 1.5 m / 4.0 m



Emergency door release tool

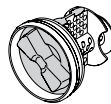

Foreign body trap

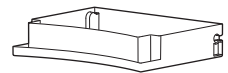

Drain tray



Siphon

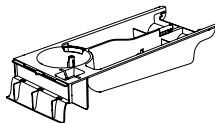

Detergent dispenser drawer

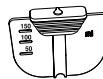

Flap for liquid detergent

13 Technical data

Dimensions

Height	85 cm
Width	59.5 cm
Depth	62.5 cm
Weight	70 kg
Pumping height of pump	1.2 m
Load capacity	8 kg dry washing

Plumbing in

Connection to water supply	Cold water G $\frac{3}{4}$ "
Permitted pressure of water supply	0.1–0.6 MPa (1–6 bar)
Max. pumping height of drain pump	1.2 m

Spin speed



400, 600, 800, 1000, 1200, 1400, 1600 rpm

Electrical connection

The electrical connection can be found on the identification plate (see page 51).

13.1 Note for testing institutes

Set to the standard programmes according to EN 60456:

Programme	Load capacity	
Standard 60 °C programme	8 kg or 4 kg	<ul style="list-style-type: none"> ▶ Touch the  button. ▶ Touch the  button. ▶ Touch the  button.
Standard 40 °C programme	4 kg	

13.2 Most efficient programmes

For normally soiled cotton laundry at 60 °C or 40 °C.

In order to save energy, the actual water temperature is lower than the programme temperature displayed for these programmes. A longer washing time, however, still ensures a very good washing performance.

Programme	Load capacity kg	Programme duration hrs./mins. ²	Water l	Energy kWh	Remaining moisture content %
Cotton 60 °C ¹	8	4h10, 4h20	55	0.69	44
	4	4h05, 4h15	36	0.52	44
Cotton 40 °C ¹	4	4h05, 4h15	36	0.48	44

¹ ▶ Select standard programme (see page 44).

² The longer programme duration is valid for 230V~ 50 Hz, 10 A mains connection.

13.3 Consumption values

The consumption data and programme times given serve only as a guide. They refer to the maximum load capacity and can vary with, for instance, towelling material, a very cold water feed, the degree of soiling selected or a smaller wash load. The time remaining shown and the programme end time are adjusted accordingly.

Whites and coloureds programmes

Programme	Load kg	Spin speed rpm ¹	Duration hrs./mins. ²	Water l	Energy kWh
Whites 95 °C	1–8	1200	1h38, 2h15	75	2.2
Coloureds 60 °C	1–8	1200	1h15, 1h32	65	1.3
Coloureds 40 °C	1–8	1200	1h05, 1h14	70	0.8
Coloureds 30 °C	1–8	1200	1h02, 1h05	70	0.5
Coloureds 20 °C	1–8	1200	0h59, 1h00	70	0.3

¹ Factory setting

² The longer programme duration is valid for 230 V~ 50 Hz, 10 A mains connection.

Extra programmes

Programme	Load kg	Spin speed rpm ¹	Duration hrs./mins.	Water l	Energy kWh
Steam anti-crease	1–1.5	0	0h23	1	0.1
Proofing 20 °C	1–3	800	0h28	12	0.2
Appliance hygiene	0	0	0h30	9	0.7

¹ Factory setting

Textile programmes

Programme	Load kg/items	Spin speed rpm ¹	Duration hrs./mins.	Water l	Energy kWh
Woollens 30 °C	1–2.5	800	0h48	52	0.3
Hand wash 20 °C	1–2	600	0h45	58	0.2
Shirts 40 °C	max. 7 items	1000	1h23	33	0.4
Down 40 °C	1°item, max.°2 kg	800	1h25	40	0.5
Outdoor garments 40 °C	3	1000	1h05	40	0.4
Silks 30 °C	1.5	400	0h48	52	0.3
Net curtains 30 °C	2	Stop after rinsing	1h00	45	0.4
Baby garments 60 °C	5	1200	1h50	120	1.6
Denim 40 °C	4	1200	1h16	55	0.5
FirstWash 20 °C	2	1000	0h15	25	0.1
Black garments 40 °C	4	1200	1h20	85	0.5

¹ Factory setting

13.4 Product fiche**In accordance with EU Regulation No. 1061/2010**

Brand	-	V-ZUG Ltd
The model identifier corresponds to the first alphanumeric characters on the identification plate.	-	11023
Rated capacity for cotton laundry at full load	kg	8
Energy Efficiency Class	-	A+++
Energy consumption of x kWh per year ¹	kWh per year	132
Energy consumption of the standard 60 °C cotton programme at full load	kWh	0.69
Energy consumption of the standard 60 °C cotton programme at partial load	kWh	0.52
Energy consumption of the standard 40 °C cotton programme at partial load	kWh	0.48
Power consumption of the off mode	W	0.15
Power consumption of the left-on mode	W	-
Water consumption x litres per year ²	litres per year	9900

In accordance with EU Regulation No. 1061/2010

Spin-drying efficiency class X on a scale from G (least efficient) to A (most efficient)	-	A
Maximum spin speed	rpm	1600
Remaining moisture content	%	44
Standard cotton programmes ³		60 °C cotton 40 °C cotton
Programme time of the standard 60 °C cotton programme at full load	min	250
With electrical connection 230V 1N 10A	min	260
Programme time of the standard 60 °C cotton programme at partial load	min	245
With electrical connection 230V 1N 10A	min	240
Programme time of the standard 40 °C cotton programme at partial load	min	245
With electrical connection 230V 1N 10A	min	240
Duration of the left-on mode	min	-
Airborne acoustical noise emissions during washing ⁴	dB (A)	48
Airborne acoustical noise emissions during spinning ⁵	dB (A)	72

1 Energy consumption x kWh per year, based on 220 standard washing cycles for cotton programmes at 60 °C and 40 °C at full and partial load, and the consumption of the low-power modes. Actual energy consumption will depend on how the appliance is used.

2 Water consumption x kWh per year, based on 220 standard washing cycles for cotton programmes at 60 °C and 40 °C at full and partial load. Actual energy consumption will depend on how the appliance is used.

3 The standard cotton programme to which the information in the label and the fiche relates. These programmes are suitable to clean normally soiled cotton laundry and are the most efficient programmes in terms of combined energy and water consumption.

4 Airborne acoustical noise emissions during washing for the standard 60 °C cotton programme at full load.

5 Airborne acoustical noise emissions during spinning for the standard 60 °C cotton programme at full load.

13.5 VAS Vibration Absorbing System

As the washing drum starts to spin, if the control system detects that the load is out of balance it will interrupt the spinning action once or more. In this case, the appliance tries to improve the distribution of the wash load in the washing drum.

When spinning, at all spin speeds the load is, where necessary, actively balanced in the washing drum, whereby the hollow vanes are filled with the necessary quantity of water. This ensures optimal care and draining of the washing.

13.6 Water and energy economy

During the first few minutes of a programme running, sensors automatically determine the type and the size of the load being washed.

Water levels are then optimally adjusted to the wash load so that only the strict amount of water needed is used.

13.7 EcoStandby

The appliance is equipped with an automatic energy-saving «EcoStandby» function to avoid consuming energy unnecessarily.

All displays go out within minutes of a programme finishing. Energy consumption is reduced to an absolute minimum. The safety functions, however, remain active.

14 Washing tips

14.1 Energy and water economy

- Where possible fill the drum to the maximum load capacity of the relevant programme.
- Select «Pre-wash» or «Soaking» only for washing that is heavily soiled or stained.
- For lightly soiled washing without staining select the «20 °C» main wash programme or the additional function «Sprint».
- Select additional function «Eco» if the duration of the programme or the germ-killing effect of high temperatures do not play a role.
- Select additional function «OptiTime» if washing using a delayed start or the germ-killing effect of high temperatures do not play a role.

Spin speed

How much energy is consumed by subsequent tumble drying depends on the spin speed set. The higher the spin speed set, the lower the remaining moisture content of the washing at the end of the programme.

rpm	1600	1400	1200	1000	800	600	400
Remaining moisture content (cotton)	~44%	~47%	~52%	~60%	~70%	~90%	~110%

Automatic door opener

Use the appliance with the automatic door opener switched on. When the appliance door opens the appliance immediately enters the lowest possible stand-by power consumption state.

14.2 Avoiding damage

- Follow the fabric care symbols on garment labels.
- The wash temperature selected should agree with the recommended temperature range of the washing detergent to ensure the washing detergent is at its most effective.
- Wash white and coloured textiles separately.
- Empty pockets and turn inside out. Remove any foreign objects (coins, nails, paper clips, etc.).
- Empty and brush out pockets of work overalls worn in the metal industry. Metal shavings can damage the washing and cause rust stains.
- Fasten hook and eye fasteners and zips. These can damage the laundry and the drum.
- Fasten cloth belts, apron ties and duvet and pillow cases to avoid them getting tangled up.

- Wash smaller items (e.g. nylon tights, belts) and items with zips and hooks in a washing net or cushion cover.
- Remove stains before washing using a suitable stain remover.
- Pre-treat heavily soiled areas (collars, cuffs, etc.) with soap, special detergent or paste.
- Textiles, such as dog or horse blankets, that are covered in animal hair should be brushed out before washing.

15 Disposal

15.1 Packaging



Never allow children to play with packaging material due to the danger of injury or suffocation. Store the packaging material in a safe location or dispose of it in an environmentally-friendly way.

15.2 Safety

Render the appliance unusable to prevent accidents caused by improper use (e.g. through children playing):

- ▶ Disconnect the appliance from the mains. With a fixed appliance, this is to be carried out by a qualified electrician. Then cut the mains cable off flush with the appliance.
- ▶ Remove or disable the lock on the appliance door.

15.3 Disposal



-  The «crossed out wheeled bin» symbol requires the separate collection of waste electrical and electronic equipment (WEEE). Such equipment can contain hazardous, environmentally harmful materials.
- These appliances are to be handed over to a designated collection point for the recycling of electrical and electronic equipment and must not be disposed of with unsorted household waste. And in this way, you will be helping to protect resources and the environment.
- For more information, please contact the local authorities.

16 Index

A	
Appliance disposal.....	49
Automatic water and energy economy.....	47
B	
Background image.....	28
Brightness.....	28
Button tone.....	28
C	
Childproof lock.....	30
Coloureds.....	10
D	
Demo mode.....	32
Detergent dispenser drawer.....	43
Cleaning.....	33
Removing.....	33
Disposal.....	49
Drain hose.....	43
Drain tray.....	43
E	
EcoManagement	
Switching on.....	30
EcoStandby.....	48
Emergency door release tool.....	43
F	
Factory settings.....	31
Favourites	
Changing.....	26
Defining.....	25
Deleting.....	26
Starting.....	27
Flap for liquid detergent.....	43
Foreign body trap.....	43
I	
Identification plate.....	51
L	
Language.....	28
M	
Malfunctions.....	37
Model designation.....	2
Model number.....	2
P	
Power failure.....	36
Problems.....	37
Q	
Queries.....	51
S	
Safety precautions	
General.....	5
Serial number (SN).....	51
Service & Support.....	51
Service agreement.....	51
Siphon.....	43
Spare parts.....	43
Symbols.....	5
T	
Textile programmes	
Starting.....	18
Type.....	2
U	
Using for the first time.....	8
V	
Validity.....	2
VAS Vibration Absorbing System.....	47
V-ZUG App.....	27
V-ZUG-Home.....	31
W	
Whites.....	10
WLAN connection.....	27

17 Service & Support



The «Trouble-shooting» section gives you valuable tips on how to deal with minor malfunctions yourself, saving you the time and trouble of calling out a service technician and any cost that goes along with it.

Information on the V-ZUG warranty can be found at www.vzug.com →Service →Warranty information. Please read this information carefully.

Please register your V-ZUG appliance straightaway:

- online at www.vzug.com →Service →Online warranty registration or
- using the enclosed registration card.

This will allow you to take advantage of the best possible support in the event of a fault in the appliance during the guarantee period. You will require the serial number (SN) and appliance designation to register your appliance. You will find them on the identification plate of your appliance.

My appliance information:

SN: _____ **Appliance:** _____

Please have this appliance information to hand when contacting V-ZUG. Thank you.

Identification plate

- ▶ Open up drain tray.
 - The identification plate is located on the left-hand side next to the foreign body trap.

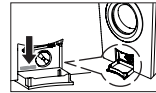

The SN can also be retrieved as follows:

- ▶ Hold the **▶▶** button depressed until «Settings – SN 11023 000123» appears in the TouchDisplay.

Your repair order

Call the free service number 0800 850 850 to contact your nearest V-ZUG service centre. You can arrange an on-site visit by us by phone if you wish.



General queries, accessories and service agreement

V-ZUG will be happy to help you with any general administrative or technical queries, to accept your orders for accessories and spare parts and to inform you about our progressive service agreements. You can contact us by calling tel. +41 58 767 67 67 or by going to our website at www.vzug.com.

Quick instructions

Please first read the safety precautions in the operating instructions.

Starting programme

- ▶ Switch on appliance and turn on water tap.
- ▶ Press the  button. Appliance door opens.
- ▶ Load laundry.
- ▶ Add washing detergent to detergent dispenser drawer.
- ▶ Select programme and any additional functions (if required).
- ▶ Press the  button. Programme starts.

When programme has finished

- ▶ Press the  button and unload the laundry.
- ▶ Clean detergent dispenser drawer.
- ▶ Push appliance door to, but do not close.



1058695-R03

